



**PREDUZEĆE ZA GRADEVINSKE, ZAVRŠNE I
OBRTNIČKE RADOVE U GRADEVINARSTVU,
INŽENJERING, PROJEKTOVANJE,
PROIZVODNJU PREFABRIKOVANIH BETONSKIH
KONSTRUKCIJA I ELEMENATA**

ul. Husein Kapetana Gradaševića bb,

Poslovni Centar

76 250 Gradačac, Bosna i Hercegovina

Centrala - tel./fax: ++387(0)35/819-466

Direktor: 819-467

Fabrika: 819-468

Projektni biro: 821-585

GSM: ++387(0)61/151-388

++387(0)61/152-244

++387(0)61/331-233

e-mail: gradex@bih.net.ba

www.gradex.com.ba

ARMIRANO BETONSKE MONTAŽNE KONSTRUKCIJE TIPA "GRADEX"

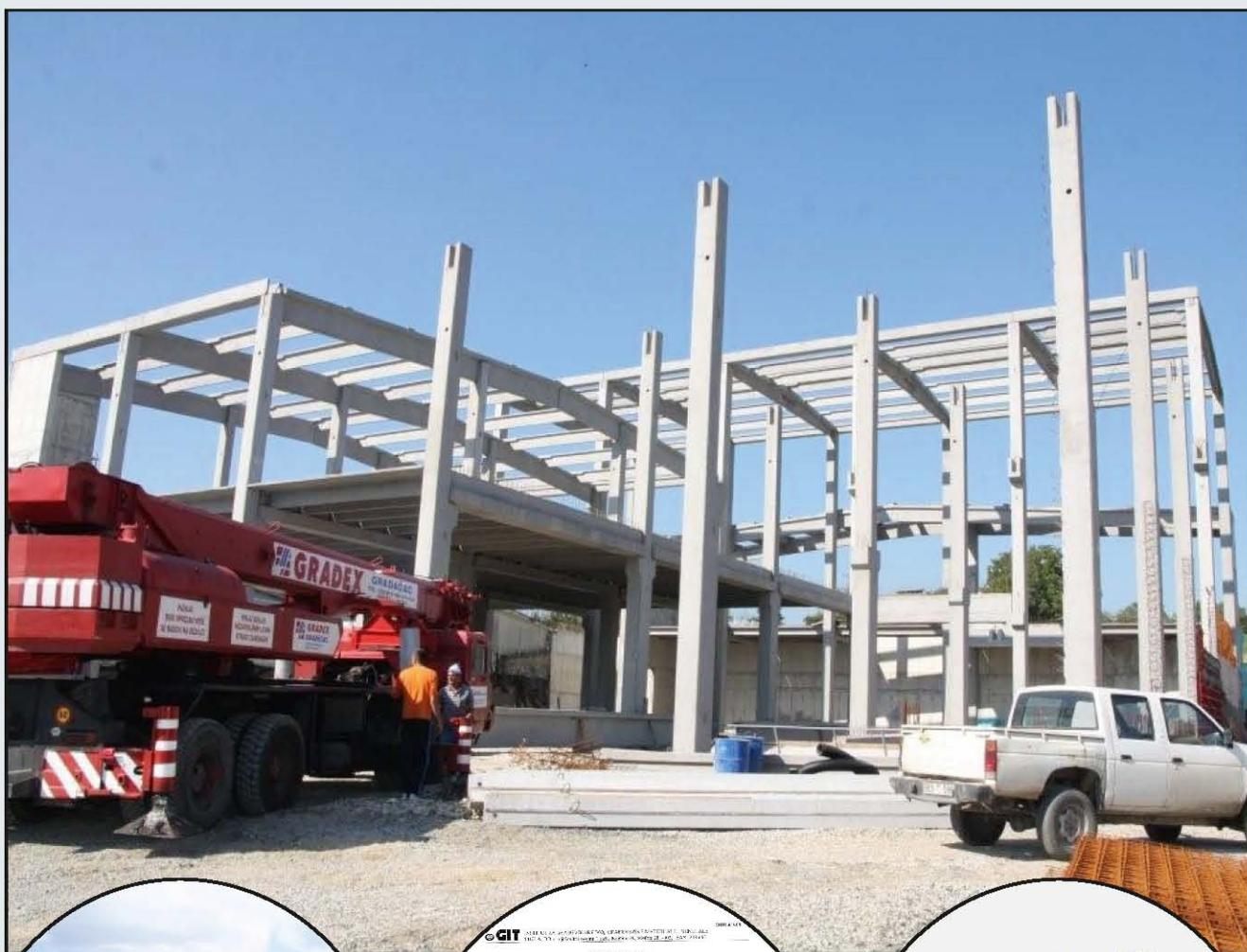



Građevinska firma u privatnoj svojini, osnovana 1991. god.

Osnovna djelatnost firme je projektovanje i izgradnja svih vrsta objekata, klasični ili montažni sistem gradnje, a djelatnost je organizovanja kroz tri organizacione jedinice i to:

- 1. Projektni biro**
- 2. Fabrika za proizvodnju i montažu armirano-betonskih konstrukcija**
- 3. Građevinska operativa - klasična izgradnja (visokogradnja i niskogradnja)**

proizvodni program

- projektovanje svih vrsta objekata niskogradnje i visokogradnje**
- izgradnja montažnih objekata raspona do 32,00 m i visina do 24,00 m sa ili bez prednaprezanja kao što su poslovni objekti, skladišni objekti, trgovački objekti, poljoprivredni objekti, sportski objekti i sl...**
- izgradnja objekata visokogradnje klasičnim sistemom gradnje kao što su stambeni objekti, individualni objekti, kućni bazeni i sl...**
- izgradnja objekata niskogradnje, mostovi i nadvožnjaci raspona do 30,00 m, propusti, bazeni, saobraćajnice i sl...**
- izgradnja po sistemu "ključ u ruke"**

1. PROJEKTI BIRO:

Projektujemo sve vrste objekata, od malih kuća za stanovanje, do većih stambenih objekata, kućnih bazena, industrijskih objekata, benzinskih pumpi, poljoprivrednih objekata, poslovnih objekata, sportskih objekata i sl....

Sistem projektovanja je moderan i potpuno kompjuterizovan.

- poslovni, indistrijski i drugi objekti.

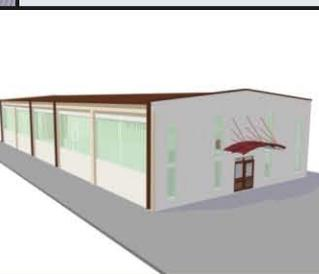
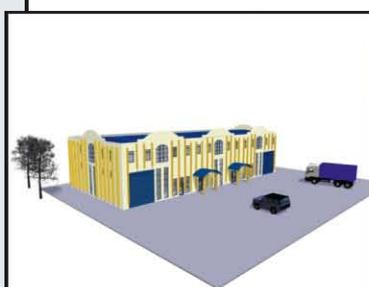
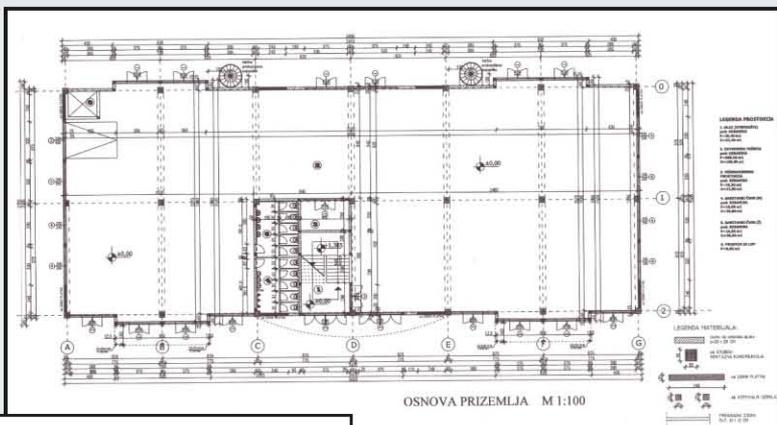

- stambeni i stambeno - poslovni objekti.



2. IZGRADNJA MONTAŽNIH OBJEKATA

- proizvodni program -

ZT program

A program

T program

K program

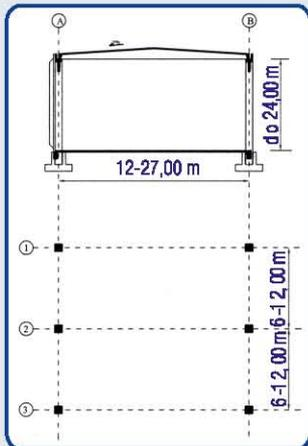

- Osovinski rasponi: **(12,13,14,15,... I 27,00 m)**
- Osovinski rasteri stubova: **(6-12,00 m)**
- Visina: do 24,00 m, (mogućnost izrade u više etaža)

Osnovni konstruktivni elementi:

- TEMELJNE STOPE
- TEMELJNE GREDE
- STUBOVI
- MEĐUETAŽNE GREDE
- MEĐUETAŽNE PI PLOČE
- KROVNE "T" GREDE
- KROVNI "ZT" NOSAČI SA AB PLOČOM SA ILI BEZ PREDNAPREZANJA**
- ZIDOVI
- FASADNE PLOČE (ravne ili sa rebrima) sa ili bez termoizolacije

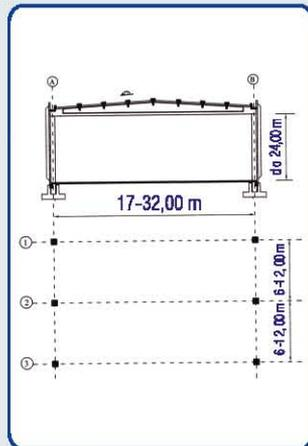

- Osovinski rasponi: **(16-32,00 m)**
- Osovinski rasteri stubova: **(6-12,00 m)**
- Visina: do 24,00 m, (mogućnost izrade u više etaža)

Osnovni konstruktivni elementi:

- TEMELJNE STOPE
- TEMELJNE GREDE
- STUBOVI
- MEĐUETAŽNE GREDE
- MEĐUETAŽNE PI PLOČE
- KROVNI "A" NOSAČI SA ILI BEZ PREDNAPREZANJA**
- KROVNI SEKUNDARNI NOSAČI I KORITA**
- ZIDOVI
- FASADNE PLOČE (ravne ili sa rebrima) sa ili bez termoizolacije

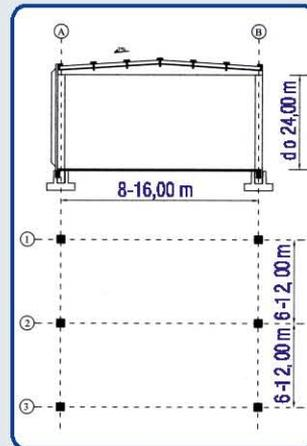

- Osovinski rasponi: **(8-16,00 m)**
- Osovinski rasteri stubova: **(6-12,00 m)**
- Visina: do 24,00 m, (mogućnost izrade u više etaža)

Osnovni konstruktivni elementi:

- TEMELJNE STOPE
- TEMELJNE GREDE
- STUBOVI
- MEĐUETAŽNE GREDE
- MEĐUETAŽNE PI PLOČE
- KROVNI "T" NOSAČI**
- KROVNI SEKUNDARNI NOSAČI**
- ZIDOVI
- FASADNE PLOČE (ravne ili sa rebrima) sa ili bez termoizolacije

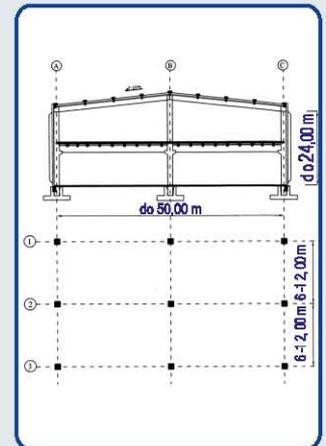

- Osovinski rasponi od ose A do ose C: **(do 50,00 m)**
- Osovinski rasteri stubova: **(6-12,00 m)**
- Visina: do 24,00 m, (mogućnost izrade u više etaža)

Osnovni konstruktivni elementi:

- TEMELJNE STOPE
- TEMELJNE GREDE
- STUBOVI
- MEĐUETAŽNE GREDE
- MEĐUETAŽNE PI PLOČE
- KROVNI "T" NOSAČ- GREDA SA AB PLOČOM SA ILI BEZ PREDNAPREZANJA**
- KROVNI SEKUNDARNI NOSAČI I KORITA**
- ZIDOVI
- FASADNE PLOČE (ravne ili sa rebrima) sa ili bez termoizolacije

Svi elementi sistema su montažni i proizvode se u metalnim kalupima, pa je gradnja ekonomična i brza, a montaža samog objekta jednostavna.

Prednost navedene vrste gradnje je industrijska proizvodnja, brza montaža, fleksibilnost sistema, moguća namjena i upotreba za različite raspone i visine, te višestruka prilagodljivost arhitektonskim, klimatskim i seizmičkim uslovima.

Kvaliteta proizvedenih elemenata i montaža objekata je standardna i pod stalnim nadzorom instituta.

izgradnja objekta



...od početka do kraja....





PROGRAM

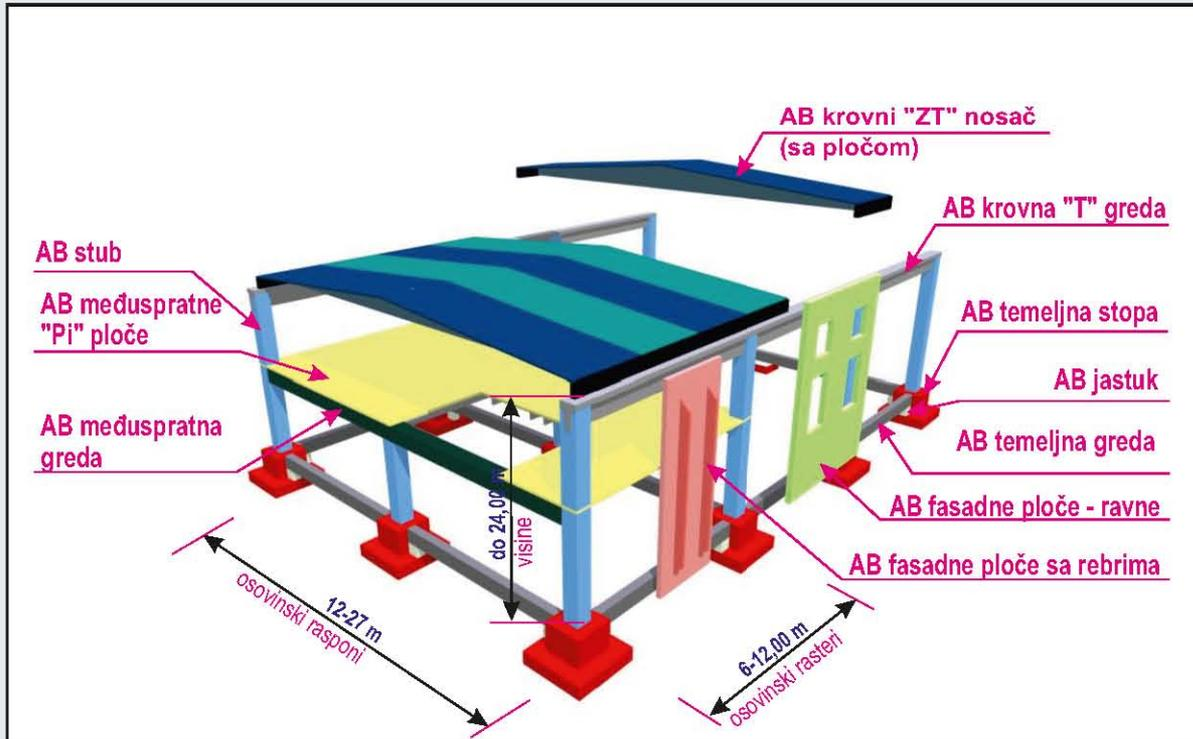



PROGRAM





PROGRAM

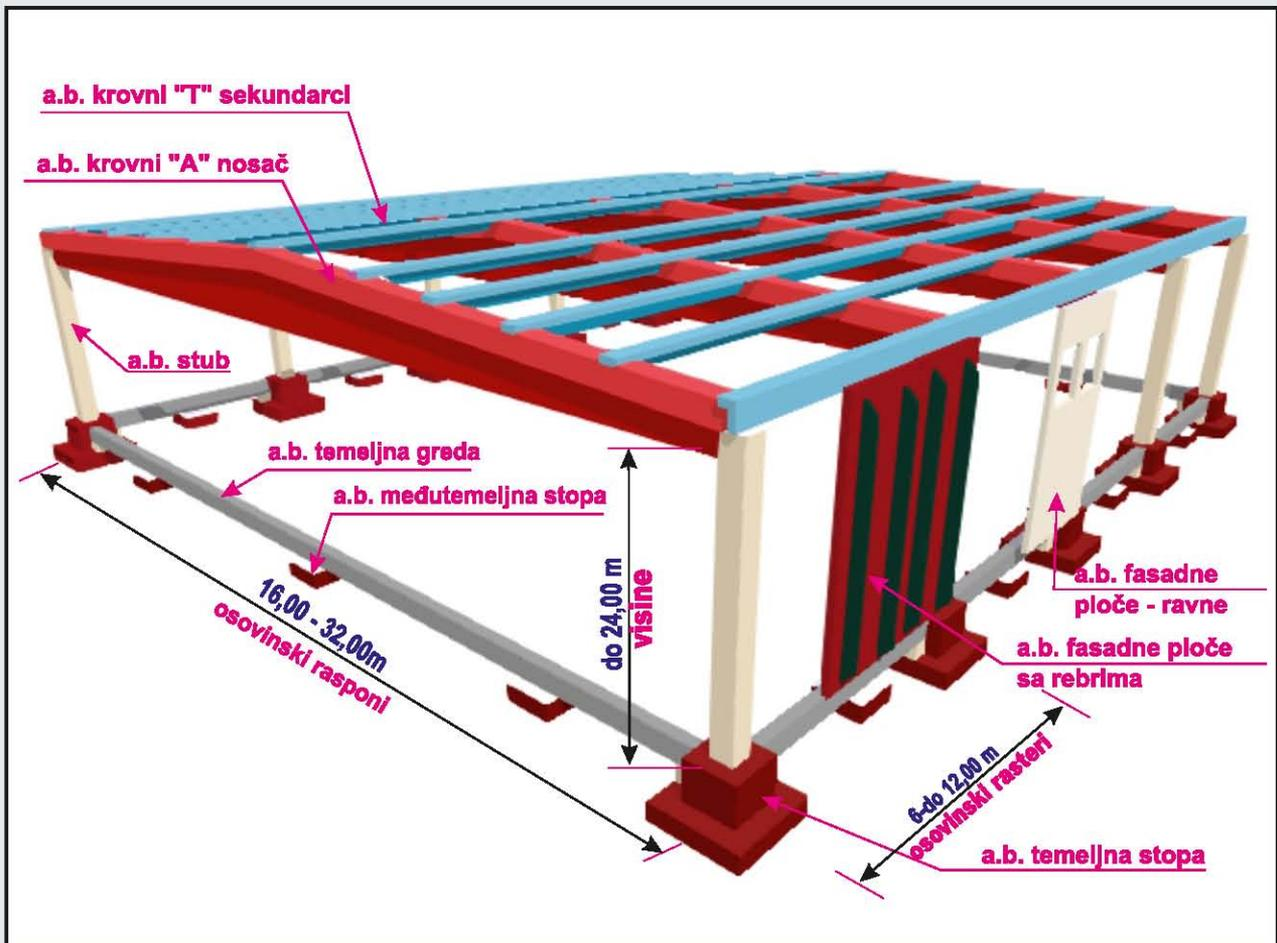



PROGRAM





PROGRAM

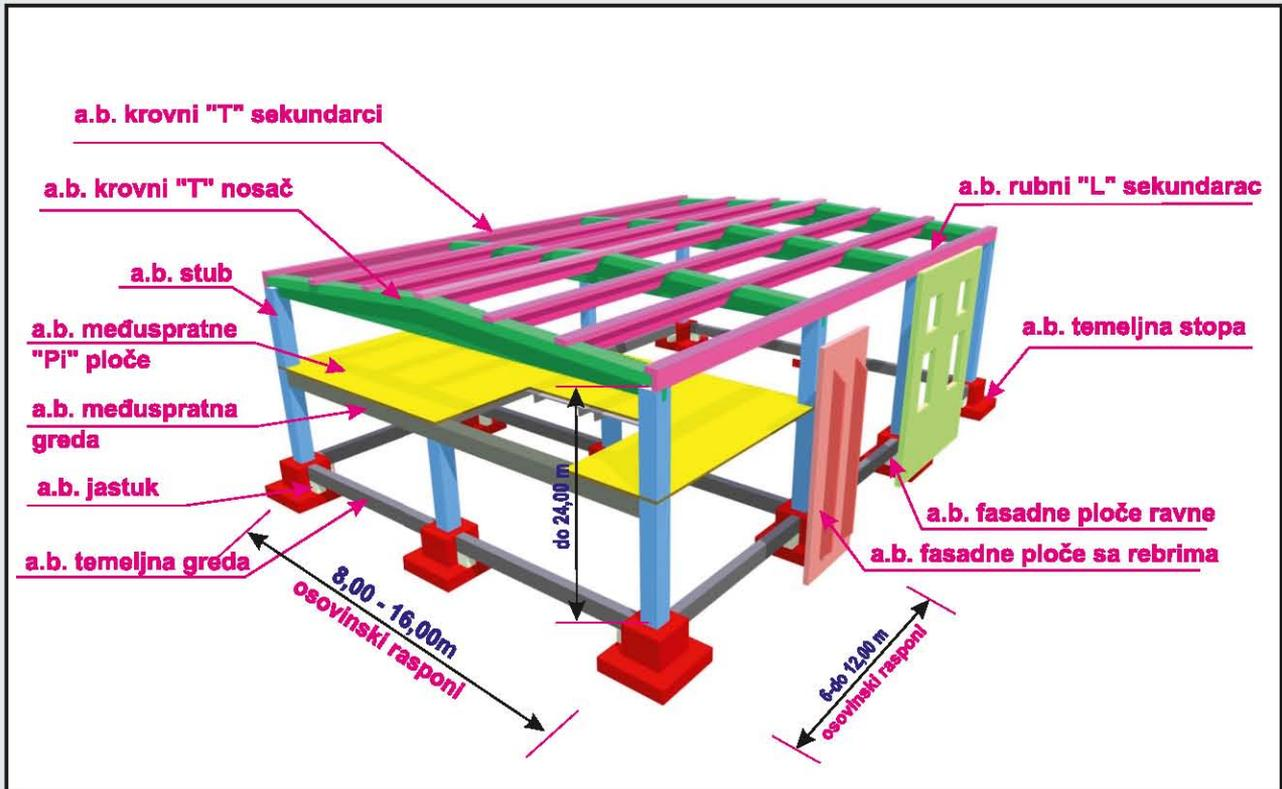



PROGRAM





PROGRAM

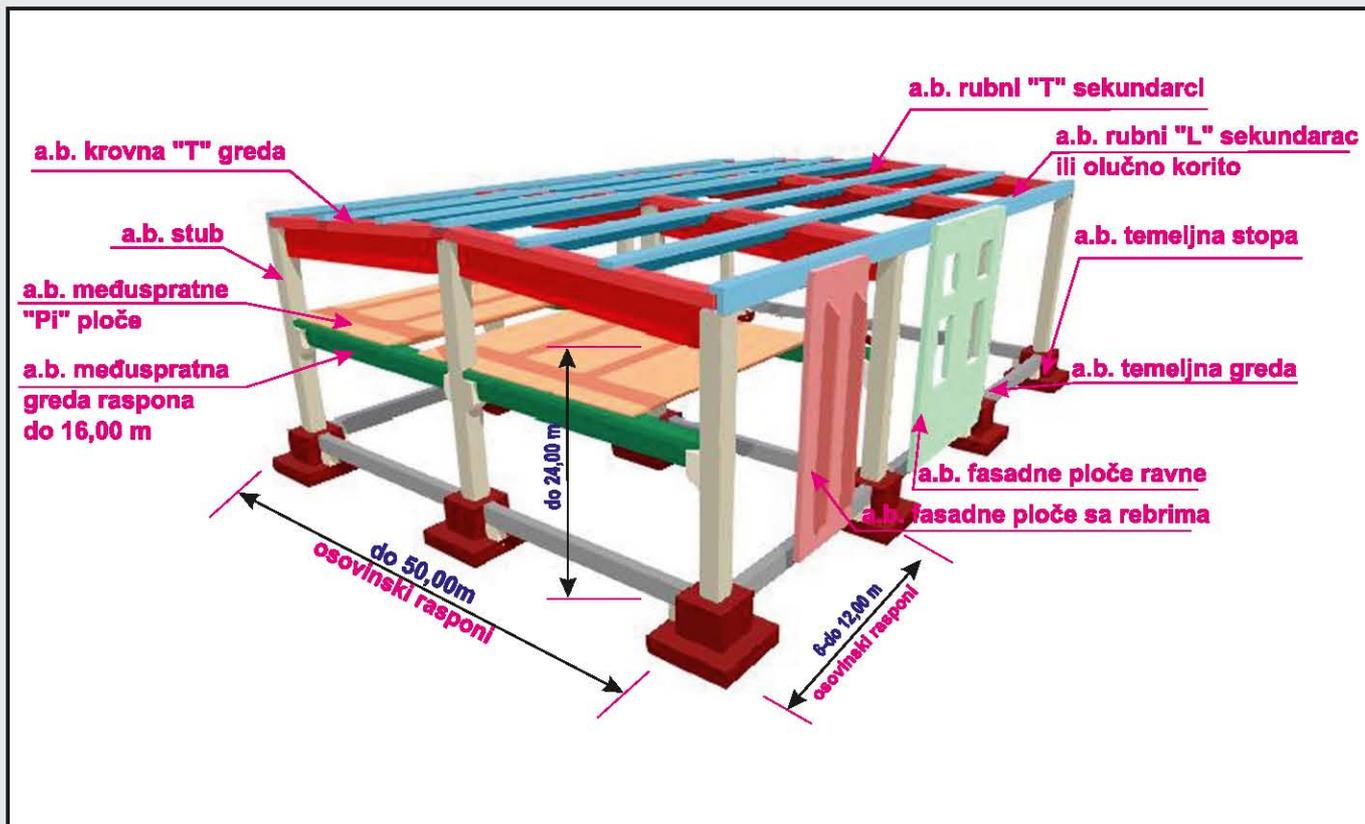



PROGRAM





PROGRAM



- ab konstrukcija - montažni temelji:



**- ab fasadne ploče (ravne ili sa rebrima)
betonski termoizolacioni sendvič zidovi:**



- detalj montažne konstrukcije:



REFERENS LISTA: - poslovni, skladišno-prodajni i proizvodni objekti





**Trgovinsko-proizvodni objekat
"Master Wood" Brčko**



**Trgovinski centar
"Belamionix" Mionica Gradačac**



**Trgovinsko-skladišni objekat
"Mešić-Com" Ledenice Gradačac**



**Trgovački centar
"Tropic" Brčko**



**Trgovački centar
"Swon" Valpovo Hrvatska**



**Trgovački centar
Bosanski Brod**



**Proizvodno skladišni objekat
"Pinoles" Nova Pazova
Srbija**



**Proizvodno skladišni objekat
"Pinoles" Nova Pazova
Srbija**



**Trgovački centar
Bosanski Šamac**



**Skladišni objekat
"Mlin Majić" Hrgovi Donji
Gradačac**



**Farme "Raklč-komerc"
Batković - Bijeljina**



**Skladišni objekat
"Sinedo komerc"
Ormanica Gradačac**



**Skladišni objekat
"Bosnaprodukt" Gradačac**



**Prodajno skladišni objekat
"Voker"
Ormanica Gradačac**



**Skladišni objekat
"Studen & Co.Arex"
Kerep - Gradačac**



**Prodajno-skladišni objekat
Cerik Brčko**





**Prodajno-skladišni objekat
"Union comerce" Sarajevo**



**Prodajno-skladišni objekat
"Union comerce" Sarajevo**



**Prodajno-skladišni objekat
"Union comerce" Sarajevo**



**Prodajno-skladišni objekat
"Union comerce" Sarajevo**



**Trgovinsko-proizvodni objekat
"Lija" Gradačac**



**Trgovinsko-proizvodni objekat
"Euro Samm Plast" Gradačac**



**Prodajno-skladišni objekat
"Voće-tranzit" Kerep Gradačac**



**Fabrika obuće
"Thema" Gradačac**



**Skladišni objekat
"Euro Trans" Gradačac**



**Proizvodni objekat
Derventa**

**Prodajno-skladišni objekat
"Ordagić" Srebrenik**



**Farme "Agrex"
Donji Žabar**



**Prodajni objekat
Srebrenik**



**Trgovinski objekat
Doboj**



**Proizvodni objekat
Odžak**



**Proizvodno-skladišni objekat
Kalesija**



**Proizvodni objekat
"Netz" Gradačac**



**Hemodijalizni centar
Bosanski Šamac**



**Prodajno-skladišni objekat
Dubrave Brčko**



**Sportska dvorana
Seonjaci Brčko Distrikt**





**Proizvodni objekat
"Ammar" Gradačac**



**Prodajno-skladišni objekat
"Elestra" Kerep Gradačac**



**Fabrika metalnih proizvoda
"RM-LH" Zenica**



**Prodajno-skladišni objekat
"Brdar Komerc" Odžak**



**Proizvodni objekat
"Prijeđorčanka" Prijedor**



**Skladišni objekat
"Agro Impex"
Bosanska Gradiška**



**Skladišni objekat
"Agro Impex"
Bosanska Gradiška**



**Skladišni objekat
"Atos-Vinum" Irig Srbija**



**Skladišni objekat
"AES-Trans" Kerep Gradačac**



**Skladišni objekat
"AES-Trans" Kerep Gradačac**

Benzinske pumpe:

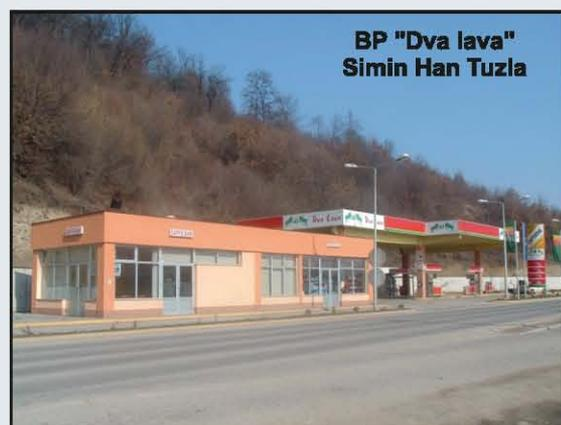
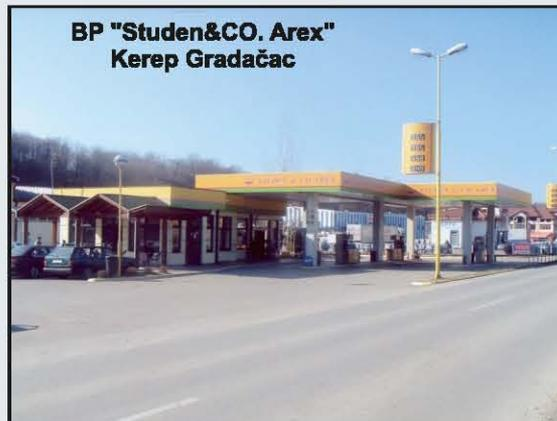



Mostovi:



Stambeni objekti:





Bazeni:

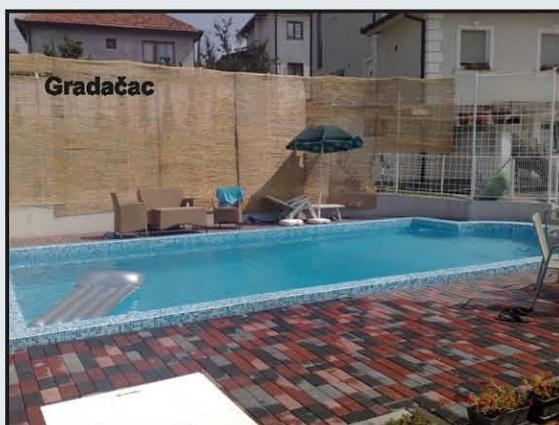

Referens lista:

- Izgrađenih objekata:
- poslovni, skladišno-prodajni i proizvodni objekti
 - benzinske pumpe
 - mostovi
 - stambeni objekti
 - bazeni i dr.

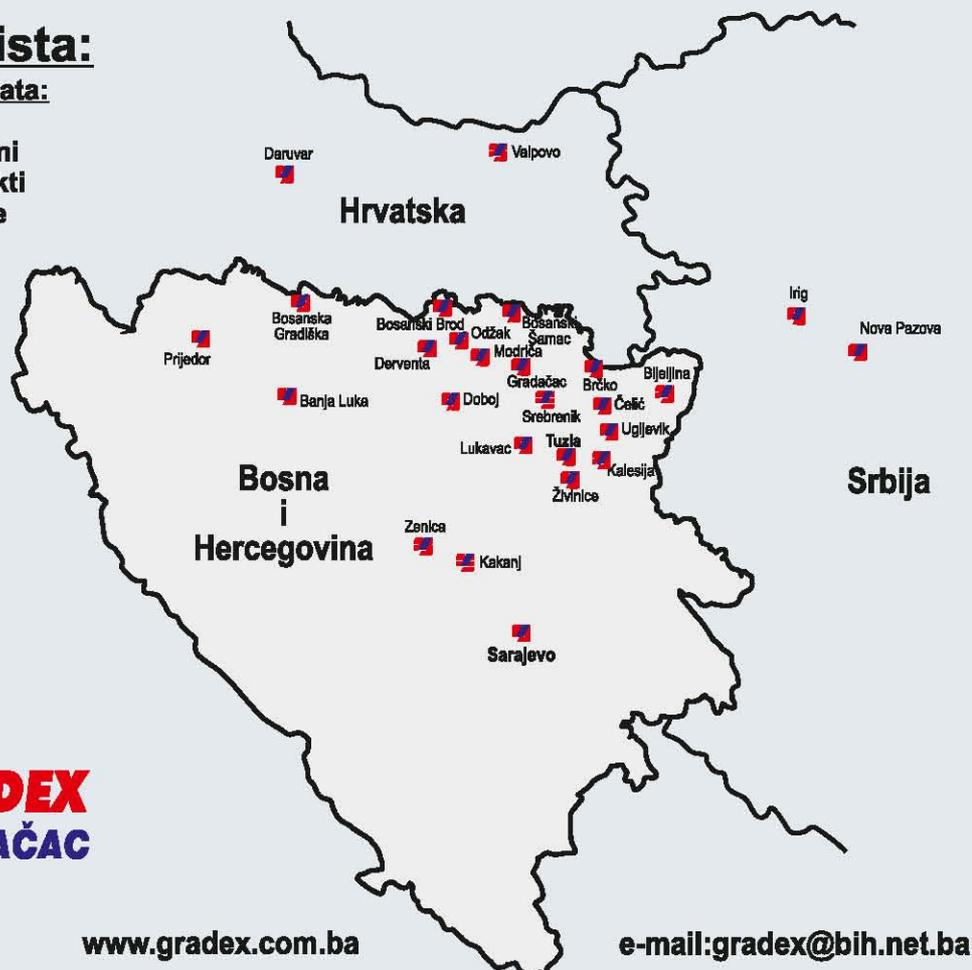

www.gradex.com.ba

[e-mail:gradex@bih.net.ba](mailto:gradex@bih.net.ba)